

**Rectifier diodes
Schottky barrier**

PBYR345CTD series

FEATURES

- Low forward volt drop
- Fast switching
- Reverse surge capability
- High thermal cycling performance
- Low thermal resistance

SYMBOL

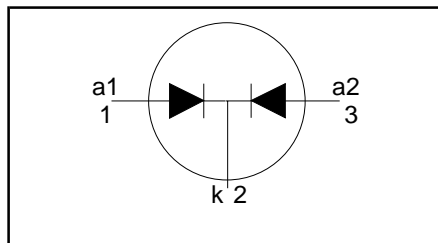

QUICK REFERENCE DATA

$V_R = 40\text{ V} / 45\text{ V}$
$I_{O(AV)} = 3\text{ A}$
$V_F \leq 0.57\text{ V}$

GENERAL DESCRIPTION

Dual schottky rectifier diodes intended for use as output rectifiers in low voltage, high frequency switched mode power supplies.

The PBYR345CTD series is supplied in the SOT428 surface mounting package.

PINNING

PIN	DESCRIPTION
1	anode 1
2	cathode ¹
3	anode 2
tab	cathode

SOT428

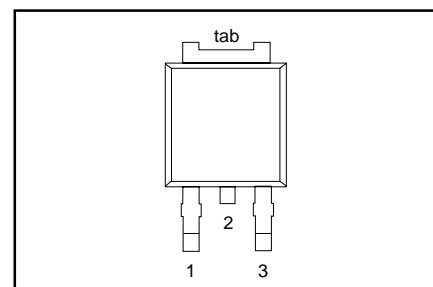

LIMITING VALUES

Limiting values in accordance with the Absolute Maximum System (IEC 134)

SYMBOL	PARAMETER	CONDITIONS	MIN.	MAX.		UNIT
				40CTD	45CTD	
V_{RRM}	Peak repetitive reverse voltage	PBYR3 $T_{mb} \leq 115\text{ }^\circ\text{C}$	-	40	45	V
V_{RWM}	Working peak reverse voltage		-	40	45	V
V_R	Continuous reverse voltage		-	40	45	V
$I_{O(AV)}$	Average rectified output current (both diodes conducting)	square wave; $\delta = 0.5$; $T_{mb} \leq 142\text{ }^\circ\text{C}$	-	3		A
I_{FRM}	Repetitive peak forward current per diode	square wave; $\delta = 0.5$; $T_{mb} \leq 142\text{ }^\circ\text{C}$	-	3		A
I_{FSM}	Non-repetitive peak forward current per diode	$t = 10\text{ ms}$	-	55		A
		$t = 8.3\text{ ms}$	-	60		A
I_{RRM}	Peak repetitive reverse surge current per diode	sinusoidal; $T_j = 125\text{ }^\circ\text{C}$ prior to surge; with reapplied $V_{RRM(max)}$ pulse width and repetition rate limited by T_{jmax}	-	1		A
T_j	Operating junction temperature		-	150		$^\circ\text{C}$
T_{stg}	Storage temperature		- 65	175		$^\circ\text{C}$

¹ it is not possible to make connection to pin 2 of the SOT428 package

 Rectifier diodes
 Schottky barrier

PBYR345CTD series

THERMAL RESISTANCES

SYMBOL	PARAMETER	CONDITIONS	MIN.	TYP.	MAX.	UNIT
$R_{th\ j-mb}$	Thermal resistance junction to mounting base	per diode both diodes	-	-	5	K/W
$R_{th\ j-a}$	Thermal resistance junction to ambient	pcb mounted, minimum footprint, FR4 board	-	50	-	K/W

ELECTRICAL CHARACTERISTICS

All characteristics are per diode at $T_j = 25\text{ }^\circ\text{C}$ unless otherwise specified

SYMBOL	PARAMETER	CONDITIONS	MIN.	TYP.	MAX.	UNIT
V_F	Forward voltage	$I_F = 1.5\text{ A}; T_j = 125\text{ }^\circ\text{C}$ $I_F = 3\text{ A}; T_j = 125\text{ }^\circ\text{C}$ $I_F = 3\text{ A}$	-	0.51 0.62 0.71	0.57 0.7 0.84	V V V
I_R	Reverse current	$V_R = V_{RWM}$ $V_R = V_{RWM}; T_j = 100\text{ }^\circ\text{C}$	-	0.05 3.2	0.2 8	mA mA
C_d	Junction capacitance	$V_R = 5\text{ V}; f = 1\text{ MHz}; T_j = 25\text{ }^\circ\text{C to } 125\text{ }^\circ\text{C}$	-	65	-	pF

Rectifier diodes
Schottky barrier

PBYR345CTD series

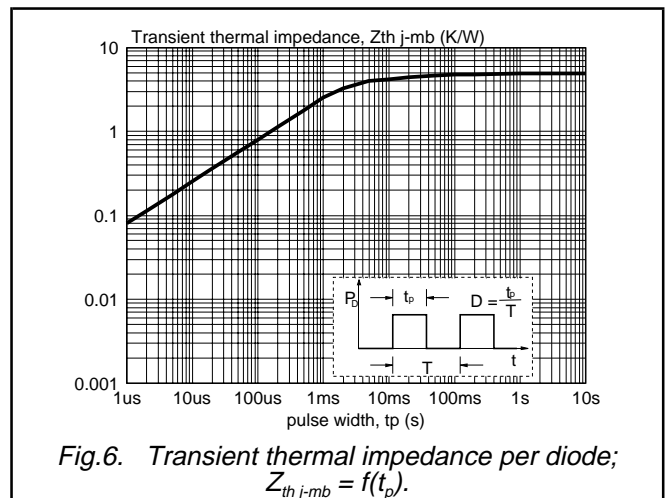
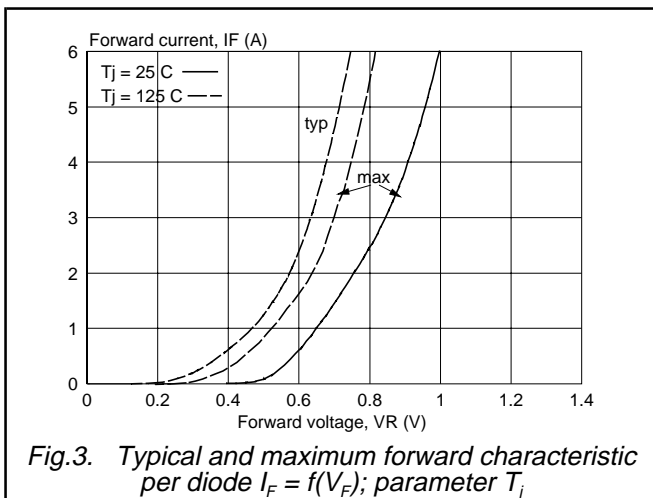
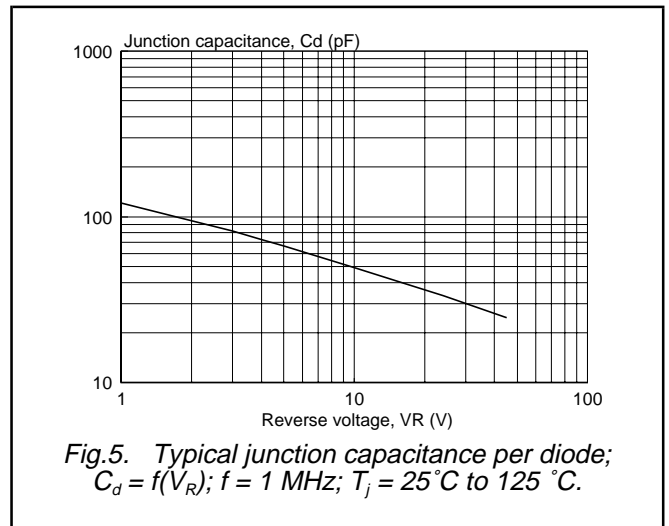
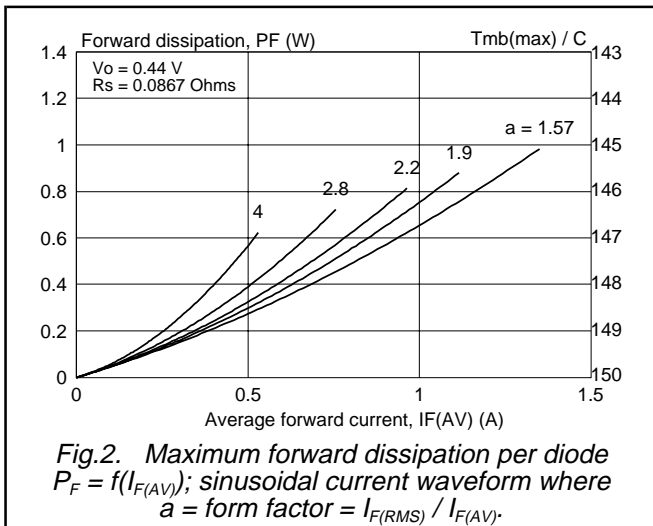
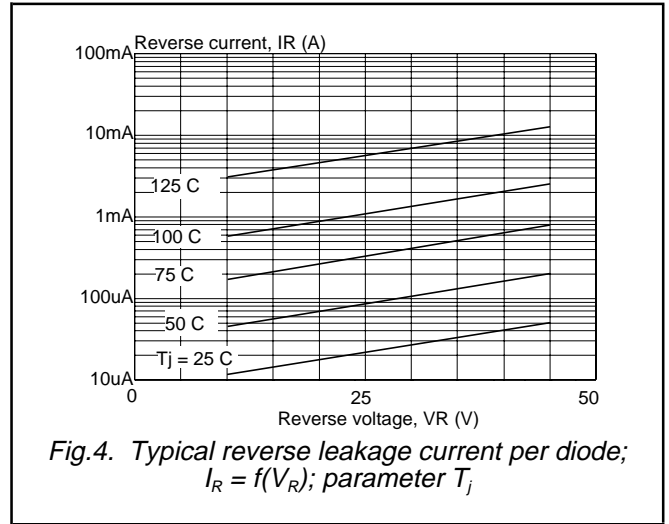
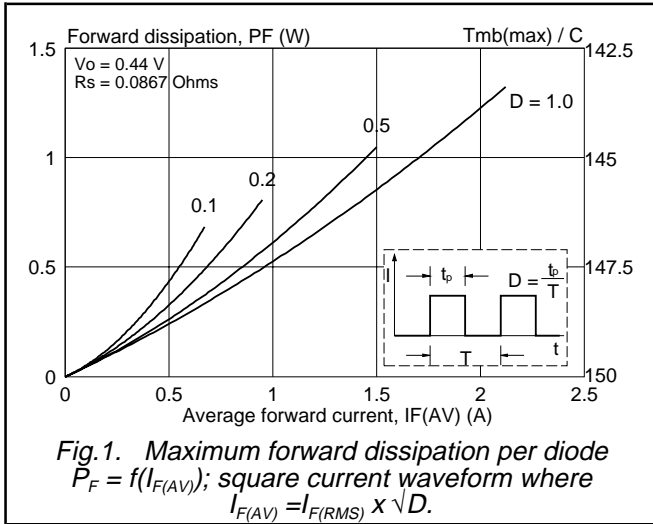

Rectifier diodes
Schottky barrier

PBYR345CTD series

MECHANICAL DATA

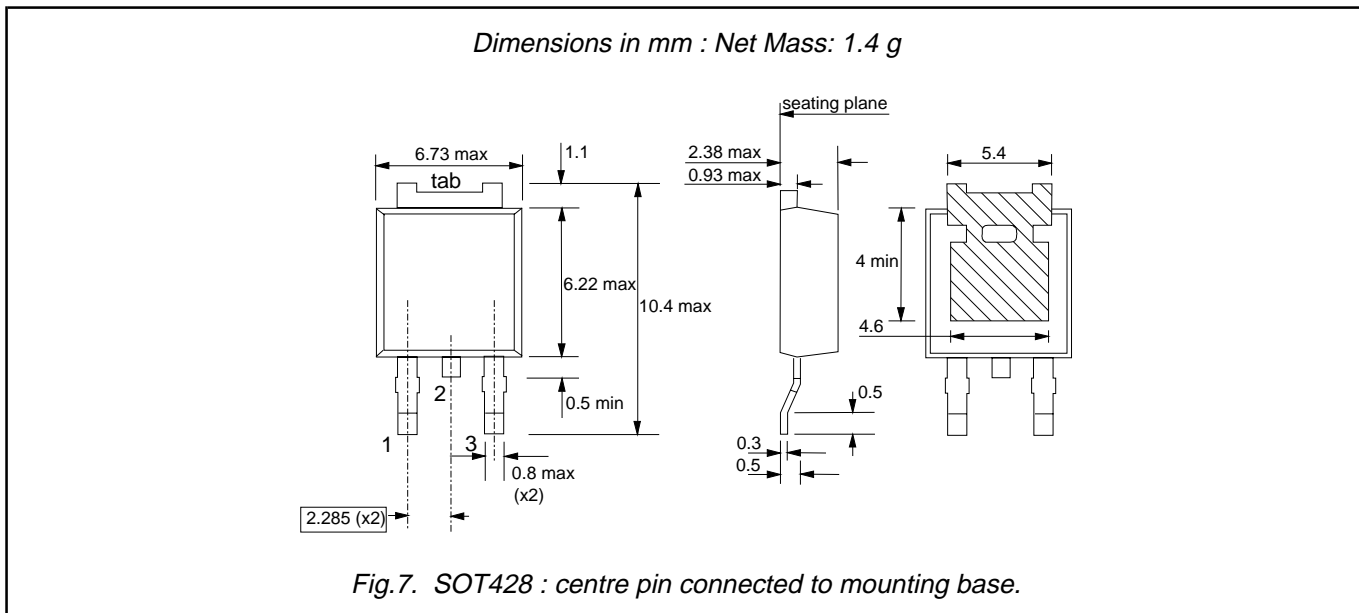

MOUNTING INSTRUCTIONS

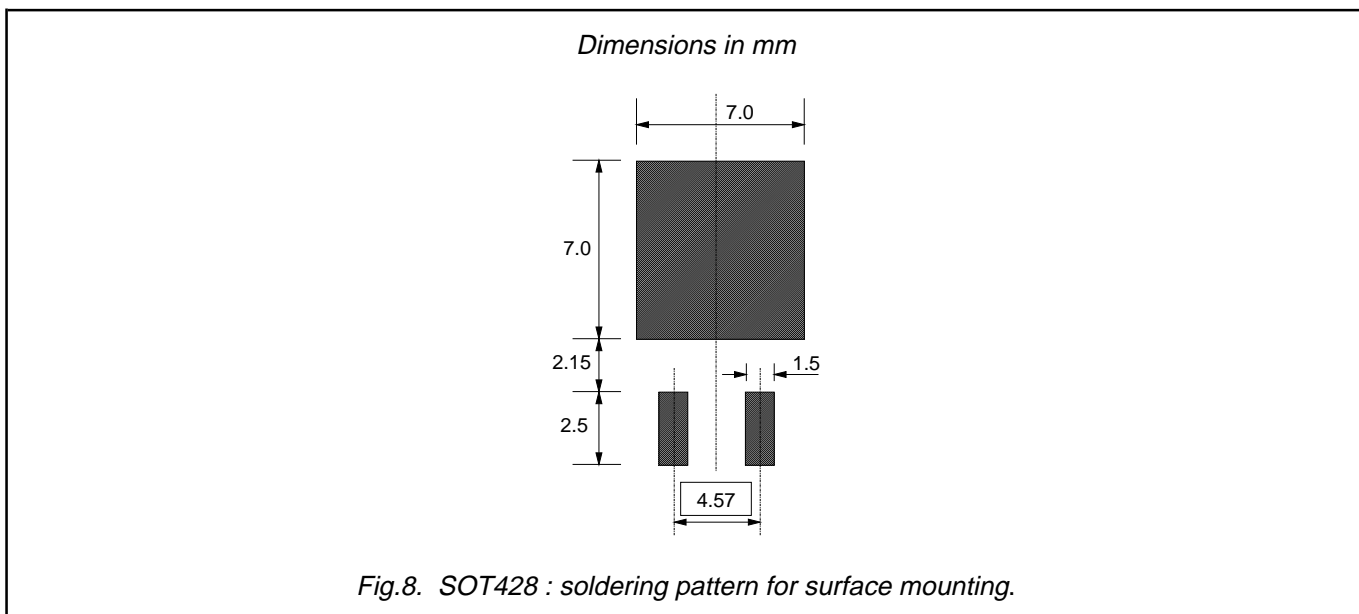

Notes

1. Observe the general handling precautions for electrostatic-discharge sensitive devices (ESDs) to prevent damage to MOS gate oxide.
2. Epoxy meets UL94 V0 at 1/8".

Rectifier diodes
Schottky barrier

PBYR345CTD series

DEFINITIONS

Data sheet status	
Objective specification	This data sheet contains target or goal specifications for product development.
Preliminary specification	This data sheet contains preliminary data; supplementary data may be published later.
Product specification	This data sheet contains final product specifications.
Limiting values	
Limiting values are given in accordance with the Absolute Maximum Rating System (IEC 134). Stress above one or more of the limiting values may cause permanent damage to the device. These are stress ratings only and operation of the device at these or at any other conditions above those given in the Characteristics sections of this specification is not implied. Exposure to limiting values for extended periods may affect device reliability.	
Application information	
Where application information is given, it is advisory and does not form part of the specification.	
© Philips Electronics N.V. 1998	
All rights are reserved. Reproduction in whole or in part is prohibited without the prior written consent of the copyright owner.	
The information presented in this document does not form part of any quotation or contract, it is believed to be accurate and reliable and may be changed without notice. No liability will be accepted by the publisher for any consequence of its use. Publication thereof does not convey nor imply any license under patent or other industrial or intellectual property rights.	

LIFE SUPPORT APPLICATIONS

These products are not designed for use in life support appliances, devices or systems where malfunction of these products can be reasonably expected to result in personal injury. Philips customers using or selling these products for use in such applications do so at their own risk and agree to fully indemnify Philips for any damages resulting from such improper use or sale.